

International Conference on Space Optics—ICSO 2006

Noordwijk, Netherlands

27–30 June 2006

Edited by Errico Armandillo, Josiane Costeraste, and Nikos Karafolas

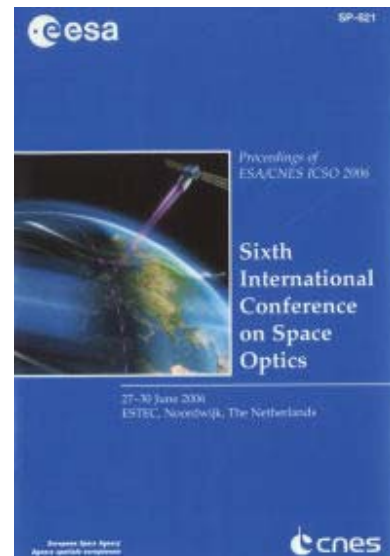

Frequency-stabilised laser reference system for trace-gas sensing applications from space

Renaud Matthey, Christoph Affolderbach, Gaetano Mileti, Stéphane Schilt, et al.



FREQUENCY-STABILISED LASER REFERENCE SYSTEM FOR TRACE-GAS SENSING APPLICATIONS FROM SPACE

⁽¹⁾ Renaud Matthey, ⁽¹⁾ Christoph Affolderbach, ⁽¹⁾ Gaetano Mileti

⁽²⁾ Stéphane Schilt, ⁽²⁾ Daniela Werner, ⁽²⁾ Sang-Hoon Chin, ⁽²⁾ Laura Abrardi, ⁽²⁾ Luc Thévenaz

⁽¹⁾ *Observatoire cantonal de Neuchâtel, rue de l'Observatoire 58, 2000 Neuchâtel, Switzerland
E-mail: renaud.matthey@ne.ch*

⁽²⁾ *Ecole polytechnique fédérale de Lausanne (EPFL), 1015 Lausanne, Switzerland
E-mail: luc.thevenaz@epfl.ch*

ABSTRACT

A four-wavelength low-power continuous-wave frequency laser reference system has been realised in the 935.4-nm range for water vapour differential absorption lidar (DIAL) applications. The system is built around laboratory extended-cavity and DFB diode lasers. Three lasers are directly locked to three water vapour absorption lines of different strength, whereas the wavelength of the fourth laser lies out of any absorption line (off-line). On-line stabilisation is performed by wavelength modulation spectroscopy technique, while precise off-line stabilisation is realised by an offset locking at 18.8 GHz. Offset frequency larger than 320 GHz has also been demonstrated at 1.55 μm , based on an all-fibre optical frequency comb. First steps towards the use of a photonic crystal fibre as ultra compact reference cell with long optical pathlength were realised. The developed techniques for direct and offset-lock laser stabilisation can also be applied to other gases and wavelengths, provided the required optical components are available for the laser wavelength considered.

1. INTRODUCTION

High-quality and reliable water vapour DIAL measurements require spectral purity $> 99.5\%$ as well as excellent accuracy, short- and long-term stabilities of the lidar operating wavelengths [1]. A way to achieve these requirements is to make use of the injection-seeding technique: a single-mode low-power cw laser that fulfils these conditions seeds a pulsed power oscillator [2-4]. Master-oscillator power-amplifier (MOPA) is another configuration, where the seed laser is pulsed amplified by optical fibre amplifiers [5] or by a single-pass tapered amplifier [6]. For enhanced humidity measurements, like airborne or satellite DIAL, synchronous operation at two or three on-line wavelengths corresponding to absorption lines of different strength may be advantageous. Here, we report on the development and evaluation of a four-wavelength frequency-stabilised laser reference system demonstrator for water vapour, further referred to as frequency detection unit (FDU). The aim is relative frequency stabilities and accuracies of $\Delta\nu/\nu \leq 2 \cdot 10^{-7}$, required for a FDU to be implemented in a satellite-borne water vapour DIAL

[7]. For the off-line wavelength, one usually relies on a wide frequency interval of low absorption and approximate laser wavelength control, for example using an injection current kick of the laser diode. In our system, not only the on-line but also the off-line wavelength are precisely controlled and stabilised.

2. SYSTEM DESCRIPTION

The 935-nm wavelength region offers absorption lines with appropriate strength and low ground-state energy for high quality DIAL water vapour measurement in the troposphere, but also in the upper troposphere and lower stratosphere [8]. Fig. 1 depicts the water spectrum around 935.4 nm in terms of absorption coefficient. The centres of the lines referred to as strong (S), medium (M) and weak (W) line with respect to their relative strength, are, together with the off-line wavelength (O), the frequency references considered in the FDU.

The frequency stabilisation scheme we used for direct locking is based on wavelength modulation spectroscopy (WMS). For pure laser wavelength modulation (WM) the zero crossing of the odd derivatives of an absorption line, which occurs at the line centre, and the linear region around this point, make them convenient for use as an error signal in a regulation loop. In reality,

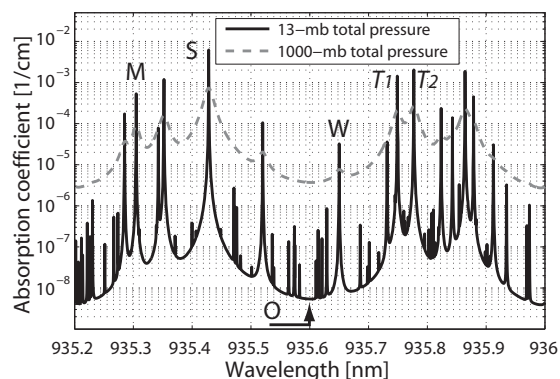

Fig. 1. Water vapour absorption coefficient spectrum in the 935.4-nm region for 13-mbar of pure water vapour (solid line) and for 13-mbar water vapour partial pressure and 1000-mbar total pressure environment (dashed line), at 23°C. In addition to the S, M, W and O-lines, T₁ and T₂ are lines used for tests.

WM is often accompanied by an undesired residual intensity modulation (IM), particularly when WM is achieved through the modulation of the laser injection current. The critical consequence, especially for small absorbance, results in an inaccurate laser locking frequency. Demodulation at the third harmonic is a possible solution to this problem, but at the cost of a much smaller signal amplitude. We preferred another approach to insure that the laser locking point coincides with the centre of the absorption line. This approach is based on the adjustment of the detection phase of the lock-in demodulation in order to remove the IM offset background in the $1f$ signal [9]. Error signal modelling also demonstrated that implementation of a balanced detection used in conjunction with WM strongly reduces the influence of the residual IM in case of small absorbance. Another effect of WM is to broaden the laser frequency excursion interval, so that the modulation must be properly chosen and controlled for subsequent injection seeding of the power oscillator.

Stabilisation of a laser at a frequency located outside any absorption feature is accomplished by stabilising it relatively to another stable frequency reference, at a precise frequency difference. The frequency reference may be another directly stabilised laser, or an intermediate optical frequency generated from a stabilised laser. For our purposes, the laser locked to the W-line serves as reference (master) to the off-line laser (slave). The frequency difference is 18.791 GHz, well within the bandwidth of commercially available detectors.

Our offset-locking scheme is sketched in Fig. 2. The beat note signal between the two lasers is detected by a fast photodetector and converted to low frequency using a mixer and an appropriate reference oscillator. In combination with a narrow low-pass filter, this arrangement can be seen as creating an artificial reference line for the beat frequency, centred at the reference oscillator frequency. After amplification, the power of the radio frequency signal is measured using an envelope detector. Wavelength modulation of the slave laser results in modulation of the beat signal, so the derivative of the filter transfer function is obtained with a lock-in amplifier (first harmonic). This signal is used as an error signal (as the $1f$ signal in the WMS technique) to control the slave laser frequency.

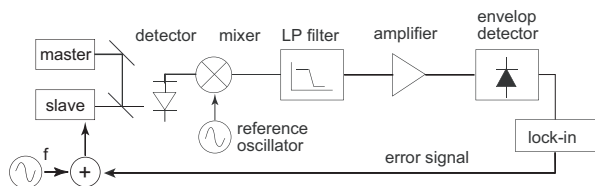

Fig. 2. Offset-locking scheme based on the stabilisation of the beat signal using a low-pass (LP) filter (230 MHz cut-off frequency) and a wavelength modulation of the slave laser.

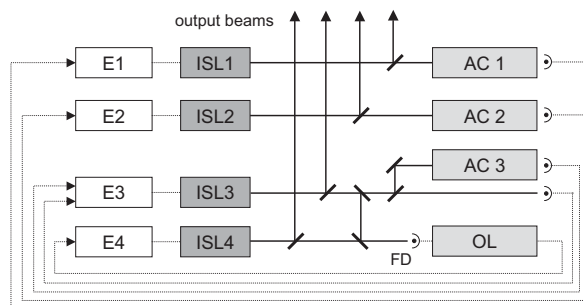

Fig. 3. Schematic diagram of the FDU instrument. ISL: injection seed laser, AC: absorption cell, OL: offset-locking subsystem, FD: fast photodetector, E: electronics module with laser control and lock-in amplifier.

The system is schematically depicted in Fig. 3. Four independent injection seed lasers (ISLs) operate in cw at wavelengths λ_1 to λ_4 , corresponding to the S, M, W absorption lines and off-line wavelength, respectively. The output of each ISL is directed to its corresponding frequency reference unit (FRU), while a beamsplitter splits off part of the laser power, which constitutes the FDU output to further injection seeding. For S and M absorption lines, the FRU consists in an absorption cell (AC1 and AC2, respectively) and a photodetector. For the W-line, the laser beam is split into two parts before the absorption cell AC3, in order to implement a balanced detection to remove the large optical offset in the $1f$ signal. A fraction of ISL3 beam is split off and combined with ISL4 into a beat note fed into the offset locking unit to stabilise ISL4. A laboratory electronics module is dedicated to each laser; it contains the laser temperature and current control as well as the frequency stabilisation servo electronics (modulation and lock-in amplifier). The cells are filled with water vapour under reduced pressure, in order to decrease the pressure-broadened linewidth down to the Doppler-limit (~ 1.2 GHz FWHM) and to increase the peak absorption for improved laser stability. Their optical pathlength ranges between 75 cm and 4 m using multipass configurations.

Implementation of three independent FRUs allows the optimisation of each FRU separately with respect to the different absorption strengths of the reference lines. It avoids frequency multiplexing complexity or multiple beam superposition problems that would arise if a single multipass cell was used. Finally, it improves the redundancy of the FDU with respect to the possible failure of one FRU.

The ISLs are based on a compact laboratory extended-cavity diode laser (ECDL) in Littrow configuration [10]. The diffraction grating position is controlled by two piezo-electric transducers. They allow fine cavity adjustment and possible extension of the mode-hop-free tuning range. This configuration offers also redundancy

Parameter	Required	ECDL	DFB
wavelength [nm]	935.4	935.4	935.4
optical power [mW]	20-30	30-40	10
current (operational) [mA]	-	75-100	30-35
linewidth (1 ms) [MHz]	< 10	0.3	2.7
FRF stability (14 s) [MHz]	< 50	0.3	1
FRF drift (24 h) [MHz]	< 500	200	100
ROP stability (14 s) [%]	--	$< 4 \cdot 10^{-3}$	$< 2 \cdot 10^{-3}$
ROP stability (3 h) [%]	--	0.12	0.04

Table 1. Overview of the ISL performances. FRF: free-running frequency (measured over 50 hours using H₂O frequency discriminators); ROP: relative optical power (measured over 24 hours). Requirements refer to values retained as objectives for space applications (airborne and ground-based applications are less demanding). Stabilities and drifts are expressed as Allan deviation. Linewidths were determined by heterodyne beat note measurement technique (see Fig. 5).

in case of failure of one of the PZTs. The dimensions of an ISL are 85 x 82 x 45 mm (0.35 litre) including an electronic circuit for protection of the laser diode, with a total mass of 330 g.

We also evaluated and implemented prototype distributed feedback (DFB) laser diodes emitting around 935 nm. With their intrinsic single-mode operation without modehop over larger wavelength intervals, DFB lasers are more reliable and easier to operate. They are more compact and less sensitive to vibrations and other environmental perturbations. Table 1 lists the main characteristics of the two types of ISL. Figure 4 shows the laboratory ECDL, whereas Figure 5 compares some examples of ISL linewidth measurements. Figure 6 shows the overall FDU. Figure 7 illustrates an example of calculated and measured absorption lines.

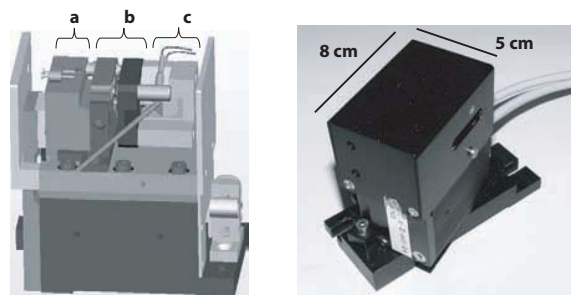

Fig. 4. Left: schematics drawing of the ECDL; (a): laser diode and collimator; (b): cavity tuning mechanism; (c): grating for light feedback and cavity outcoupling. Right: photograph of the assembled ECDL; the laser beam exits through the aperture visible on the right-hand side of the ECDL.

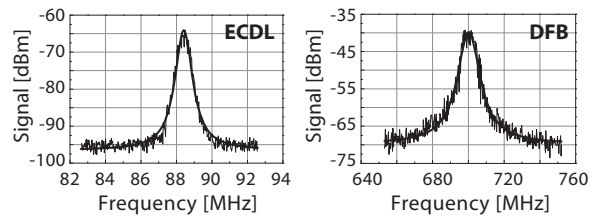

Fig. 5. Heterodyne beat spectra between two identical lasers: ECDLs (left) and DFB lasers (right). The retrieved linewidth is 300 kHz for an ECDL and 2.7 MHz for a DFB laser.

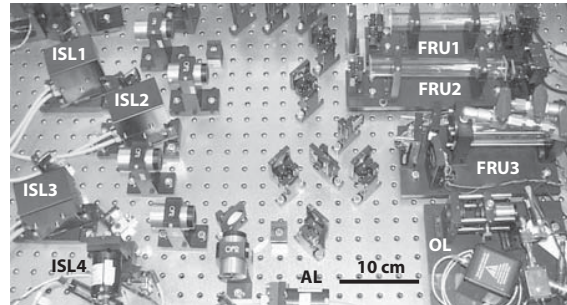

Fig. 6. Photograph of the realised FDU system. Left-hand side: the four ISL laser units. Right-hand side: the four frequency reference units (FRU1 to FRU4, from top to bottom). Middle part: transfer optics (optical isolators and beamsplitters) and additional fifth laser (AL) for test and characterisation purposes. The dimensions of the realised instrument are 75 x 53 x 15 cm³.

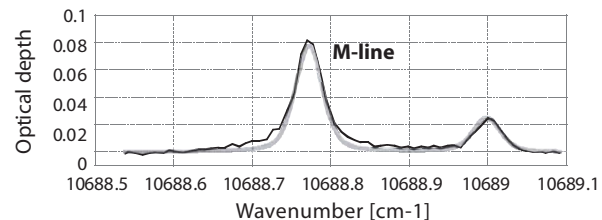

Fig. 7. Comparison of calculated (bold grey line) and experimentally measured (black thin line) absorption line for the medium strength line λ_2 (left-hand) using FRU2. For this line, the calculated data for the optical depth peak value and linewidth are 0.077 and 1.20 GHz, while 0.083 and 1.28 GHz were retrieved from the experimental fitted data.

3. STABILITY RESULTS

The frequency stability of all ISLs, respectively in free-running regime and locked to their corresponding FRUs, was measured using frequency discriminators or a high-precision wavemeter (10 MHz accuracy). The wavemeter was calibrated at 780 nm with a reference laser stabilised to a Rb Doppler-free saturated absorption resonance [10]. The results in free-running regime are given in Table 1 and shown in Figure 8.

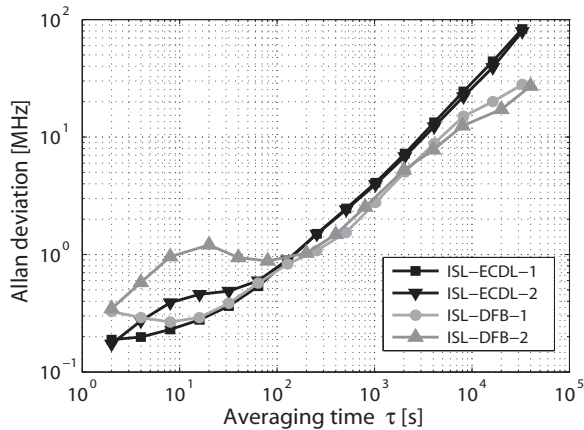

Fig. 8. Frequency stability of the free-running lasers (ISLs). The stability of each ISL was evaluated using a strong water vapour absorption line as a frequency discriminator.

For locked lasers, the stability amounts to 1-5 MHz at 1 to 10 seconds and less than 10 MHz at 1000 s for all lasers (Fig. 9). Extrapolated stabilities over one day lie between 15 MHz and 100 MHz, depending on the absorption strength of the reference line and alignment optimisation. The measured frequency stability of ISL1 is clearly limited by the stability of the wavemeter over all averaging times, but below 10 MHz. The real long-term stability of ISL2 is represented by the plateau around 8 MHz for integration times between 500 s and 4000 s. For longer averaging time, this behaviour is masked by the increasing drift of the wavemeter. The “bump” between 10 and 600 s is due to instabilities arising from optical interference fringes in the multipass reference cell (etalon effect).

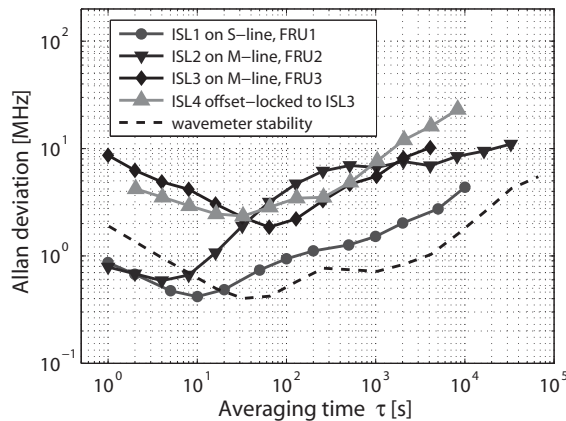

Fig. 9. Stability of the ISLs when locked to their corresponding absorption line. The stability of all ISLs was measured with a high-precision wavemeter except for ISL3. In this case a cell with 27.5-m optical pathlength and filled with water vapour was used as frequency discriminator. A modulation index of about 0.04 (50 MHz) was used for the laser dithering.

The stability of ISL3 shows the largest frequency drift over several hours due to the stronger influence of the etalon effect on the weak absorption line signal. This drift critically depends on the collimation of the laser beam and on the alignment of the FRU3 multipass cell. When extrapolated on 24-hour the stability reaches 50 MHz. The stability of ISL4 when offset-locked to ISL3 is smaller than 100 MHz on an extrapolated daily basis. The stability measurement for ISL3 and ISL4 were not realised at the same time. Their stability difference in the mid- and long-term can be explained by a lower ISL3 stability at the time of the ISL4 stability measurement caused by a not optimised optical adjustment of FRU3.

To demonstrate the correct operation of the offset locking set-up and to measure its frequency stability, two close strong absorption lines separated by 9.5 GHz were considered around 935.75 nm (in air). These lines are marked as T1 and T2 in Fig. 1. The master laser (ISL3) was locked to line T1 using the 4-m absorption cell. The other line, T2, served as a frequency discriminator for the slave laser (ISL4) when offset-locked by 10 GHz away from ISL3 (an additional shift of 0.5 GHz was added to set ISL4 on the slope of the absorption line). An external frequency generator replaced the 18.791-GHz reference oscillator. The wavelength of ISL3 was monitored by the wavemeter. The stability of the frequency difference between ISL3 and ISL4 is shown in Fig. 10. It is compared to the stability of the ISL1 locked on the strong line and shown in Fig. 9. At short-term, the difference in the stabilities can be explained by the difference in the modulated laser linewidths. Starting from averaging time above 60 s, the stabilities are identical. This demonstrates that the offset-locked laser follows the master laser and that possible instabilities provoked by the offset locking are below the wavemeter drift.

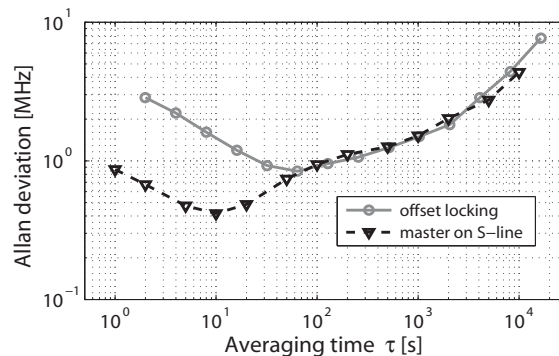

Fig. 10. Offset-locking stability evaluation of the frequency difference between the master (ISL3) and the slave (ISL4) lasers. It is a measure of the slave laser stability (offset-locked) relative to the master laser. The master laser was locked to line T1 (line strength equivalent to the S-line one).

4. POTENTIAL IMPROVEMENTS: OPTICAL COMB AND PCF-BASED REFERENCE CELLS

The offset-locking scheme has been found quite robust and simple. The major limitation of this technique lies in the maximum achievable offset frequency, which is given by the bandwidth of the fast photodetector (25 GHz in the present configuration). Much larger offset frequencies can be obtained by combining the proposed technique with an optical frequency comb (OFC). OFC made of tens to hundreds of equally spaced optical frequencies with several gigahertz frequency spacing can be generated from a single-mode laser. By locking one line of the comb to a molecular absorption line, all the OFC sidebands have a determined and stable frequency. One of these lines may then be used as a master laser to offset-lock a slave laser some gigahertz away.

We implemented an all-fibre OFC generator around 1550 nm with line frequency spacing of 2.3 GHz. When combining the OFC with the electrical filter technique offset locking larger than 150 GHz were reached, with a detector of 1-GHz bandwidth only. Performances were improved by achieving offset-locking using direct optical injection locking of a slave DFB laser. In this way, feedback electronics is no longer needed. As illustrated in Fig. 11, frequency offset up to 326 GHz (2.6 nm) was reached, limited only by the spectral tuning range of the slave laser. When the master laser is locked to a strong absorption line, a single comb could be used to lock several lasers on a master laser, for instance off-line, weak line or even medium line lasers. This can be achieved through a smart design by conveniently selecting the comb frequency spacing, so that a comb line coincides with each of the target absorption lines. A perfect match is impossible but the intrinsic linewidth and the frequency tolerance leave some freedom for a proper choice.

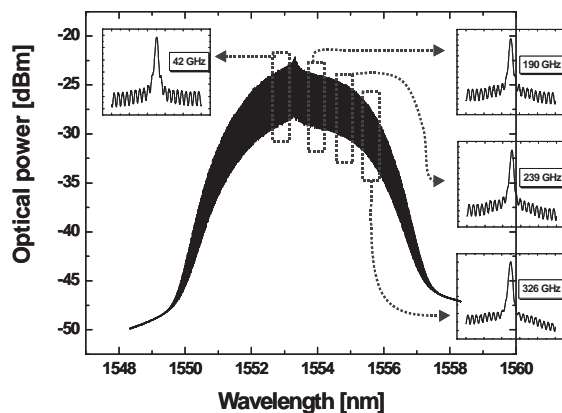

Fig. 11. OFC spectrum generated from a 1553-nm reference laser. Comb lines are spaced by 2.3 GHz. The insets display the slave laser when injection-locked to different comb lines.

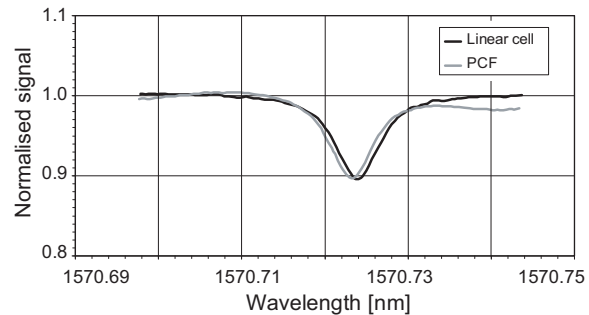

Fig. 12. Normalized transmission through a 1-m linear cell and a 1-m HC-PCF, both filled with CO₂ at reduced pressure (100 mbar). The wavelength was scanned by current tuning a DFB laser. Amplitude and width of the absorption lines are identical. The slight wavelength shift between the two measurements is due to the precision and operation repeatability of the laser temperature control.

Another possible solution to improve the stability of the laser when locked to a weak line is to increase the optical path length of the cell. A convenient solution consists in using a hollow-core photonic crystal fibre (HC-PCF) filled with water vapour at reduced pressure as a reference cell. Additional advantages offered by a HC-PCF-based cell are in terms of volume, mass and mechanical stability. Such a cell could also be used to measure the laser spectral purity. Preliminary tests performed with a HC-PCF filled with carbon dioxide at 1.57 μm are quite promising (cf. Fig. 12). Main issues are the HC-PCF filling with low-pressure gas and efficient splicing of the fibre to prevent leakage.

5. ALL-OPTICAL FIBRE CONFIGURATION

The realised configuration of the FDU breadboard is based on free-space optics and thus makes use of bulk optics (mirrors, beamsplitters, optical isolators, reference cells). In view of space application, like trace-gas profiling around the Earth by a satellite-borne DIAL instrument, this configuration presents drawbacks in terms of reliability, alignment, stability, volume, mass, temperature stabilisation. These aspects could be greatly improved when considering an all-fibre configuration, based on an all-fibre OFC generator and HC-PCF or small fibre-pigtailed reference cells.

An all-fibre configuration has the advantages to greatly simplify beam alignment and beam superposition with perfect overlap. The optical circuit is also intrinsically mechanically more stable, with quite reduced possibility of mechanical drifts and misalignments. The light confinement in the fibres avoids screening by objects, dust or exhausts, and reduces spurious signal interference to other instruments. The mass and the space occupancy of the FDU circuit is massively reduced. The power oscillator (PO) laser and the FDU can be physically separated.

rated with the injection light delivered by fibres. Coming out of a fibre, the beam has a good mode quality, which helps for efficient injection seeding.

Possible drawbacks of an all-fibre configuration mainly lie in the availability of the fibre optical components at the wavelength of interest, that can be problematic and must be insured. Furthermore, light polarisation control needs to be guaranteed for generation of beat-note signals. Injection seeding of the power oscillator also requires mode matching and hence polarised light. Use of polarisation maintaining fibre elements is required to overcome this problem.

6. CONCLUSIONS

A four-wavelength optical reference system for water vapour applications in the 935-nm range has been developed. Three lasers are locked to water vapour absorption lines while the last laser is locked off-line. For lasers locked to water vapour lines with large or medium strength – lines S and M in this work –, frequency stabilities below 15 MHz were observed on a daily basis. The observations were limited by the precision of the measurement instrument. The frequency stability degrades to 50 MHz (over 24 hours) for a weak absorption line.

Promising results of large frequency offset-locking (frequency difference up to some hundreds of gigahertz) have been obtained at 1.55 μm when using an optical frequency comb. Such a scheme could serve to lock several lasers on a master laser (itself locked to a strong absorption line), for instance off-line, weak line or even medium line lasers. Employing a stabilised (self-referenced) mode-locked femtosecond laser and a suitable accurate local oscillator would even avoid the necessity of any water vapour reference [11]. However, complexity of the system might increase.

First tests with a HC-PCF filled with CO_2 showed that this new type of fibres can perfectly play the role of a spectroscopic reference cell. None of the stabilisation schemes and techniques developed in this work are restricted to water vapour applications; they can also be applied to other trace gases.

AKNOWLEDGEMENTS

The authors would like to acknowledge the European Space Agency ESA (ESTEC Contract No. 17267/03/NL/CH), the Canton de Neuchâtel, the Ecole polytechnique fédérale de Lausanne and the Swiss national science foundation (Projects 200020-105624 and R'Equip 2160-06749) for their financial support.

REFERENCES

1. J. Bösenberg, Appl. Opt. 37, 3845 (1998)
2. J. Barnes, et al., IEEE J. Qu. Electr. 29, 2684 (1993)
3. K. Ertel, et al., Opt. 44, 5120 (2005)
4. A. Fix, et al., Opt. 7, 837 (1998)
5. L. Little, G. Papen, Appl. Optics 40, 3417 (2001)
6. J. Machol, et al., Appl. Optics 43, 3110 (2004)
7. A. Hélière, et al., in *Proceedings of the Fifth International Conference on Space Optics, Toulouse, 30 March-2 April 2004* (ESA SP-554 2004)
8. G. Poberaj, et al., Appl. Phys. B 75, 165 (2002)
9. S. Schilt, et al., Appl. Opt. 42, 6728 (2003)
10. C. Affolderbach, G. Mileti, Rev. Sci. Instrum. 76, 073108 (2005)
11. L. Hollberg, et al., Metrologia 42, S105 (2005)