

International Conference on Space Optics—ICSO 2022

Dubrovnik, Croatia

3–7 October 2022

Edited by Kyriaki Minoglou, Nikos Karafolas, and Bruno Cugny,

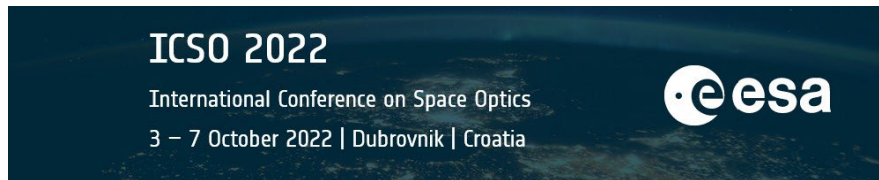

Optical design and performance simulations for the 1.49 keV beamline of the BEaTriX X-ray facility



Optical design and performance simulations for the 1.49 keV beamline of the BEaTriX X-ray facility

D. Spiga^{*,1}, B. Salmaso,¹ S. Basso,¹ C. Pellicciari,² C. Ferrari,³ R. Lolli,³ M. Ghigo,¹ G. Sironi,¹ G. Vecchi,¹
V. Cotroneo,¹ G. Pareschi,¹ G. Tagliaferri,¹ D. Sisana,^{4,1} V. Burwitz,⁵ S. Rukdee,⁵ G. Hartner,⁵
T. Müller,⁵ T. Schmidt,⁵ A. Langmeier,⁵ D. Della Monica Ferreira,⁶
N. C. Gellert,⁶ S. Massahi,⁶ M. Bavdaz,⁷ I. Ferreira⁷

¹*INAF-Osservatorio Astronomico di Brera, Via E. Bianchi 46, 23807 Merate (Italy)*

²*IIS Bachelet, Via Stignani 63/65, 20081 Abbiategrasso, Milano, Italy*

³*IMEM-CNR, Parco Area delle Scienze 37/A, 43124 Parma (Italy)*

⁴*Politecnico di Milano-Bovisa, via G. La Masa 1, 20156 Milano (Italy)*

⁵*Max-Planck-Institut für extraterrestrische Physik, Garching (Germany)*

⁶*DTU-space, Juliane Maries Vej 30, DK-2100 Copenhagen (Denmark)*

⁷*European Space Agency, Keplerlaan 1, 2201 AZ Noordwijk (Netherlands)*

ABSTRACT

The BEaTriX (Beam Expander Testing X-ray) facility, now operational at INAF-Brera Astronomical Observatory, will represent a cornerstone in the acceptance roadmap of Silicon Pore Optics (SPO) mirror modules, and will so contribute to the final angular resolution of the ATHENA X-ray telescope. By expansion and collimation of a microfocus X-ray source via a paraboloidal mirror, a monochromatization stage, and an asymmetric crystal, BEaTriX enables the full-aperture illumination of an SPO mirror module with a parallel, monochromatic, and broad (140 mm × 60 mm) X-ray beam. The beam then propagates in a 12 m vacuum range to image the point spread function of the mirror module, directly on a focal plane camera. Currently the 4.51 keV beamline, based on silicon crystals, is operational in BEaTriX. A second beamline at 1.49 keV, which requires a separate paraboloidal mirror and organic crystals (ADP) for beam expansion, is being realized. As for monochromators, the current design is based on asymmetric quartz crystals. In this paper, we show the current optical design of the 1.49 keV beamline and the optical simulations carried out to predict the achievable performances in terms of beam collimation, intensity, and uniformity. In the next future, the simulation activity will allow us to determine manufacturing and alignment tolerances for the optical components.

Keywords: BEaTriX, X-ray test facility, optical design, optical simulations, beam expander, ADP

1. THE BEATRIX X-RAY FACILITY

ATHENA, the largest X-ray telescope ever built, is progressing towards its realization.^[1] It will have a focusing mirror assembly of 2.5 m in diameter, with an unprecedented effective area of 1.4 m² at 1 keV, and an angular resolution HEW (Half Energy Width) of 5 arcsec or better. This ambitious target is being reached using the technology of Silicon Pore Optics (SPO) under development at ESA and *cosine*, which will enable to manufacture modular elements (mirror modules, MMs) of densely-nested focusing optics with very low mass-to-effective area ratio and high stiffness.^[2] The latest ATHENA design foresees the co-focal integration of 600 MMs into the mirror assembly (MA): each of them needs to be tested, measuring its Point Spread Function (PSF) and its Effective Area (EA) directly in X-rays, prior to integration with a common focus.^[3] In order to keep up with the expected production rate of 2 MM/day, an appropriate X-ray test facility shall generate a broad and parallel beam, at the same time avoiding the need of evacuating large volumes, thereby minimizing the time required for MM replacement. BEaTriX,^{[4][5][6][7][8]} the Beam Expander X-ray facility, has been developed at INAF – Osservatorio Astronomico di Brera (Merate, Italy) to the specific aim of

* corresponding author: daniele.spiga@inaf.it, phone +39-0272320-427

fulfilling these requirements, and so perform a systematic X-ray test of modular optics, such as ATHENA’s within a small lab space (9 m × 18 m). Currently operational and calibrated at 4.51 keV,^[9] BEaTriX takes just 2 h for venting, installing an MM, pumping the vacuum down, and align the MM into the X-ray beam, which makes BEaTriX much faster than large X-ray calibration facilities like PANTER at MPE.^[10] The X-ray beam at 4.51 keV has a 17 cm × 6 cm size in order to fully illuminate the full aperture of the widest MMs in the current design of ATHENA, so as to avoid the need to scan the beam and reconstruct the PSF, as currently done at the XPBF 2.0 beamline of BESSY II.^[11] Moreover, the beam is parallel and collimated within a few arcseconds in order to mimic an astronomical X-ray sources, and so meaningfully reproduce the focal spot at the nominal focal distance.

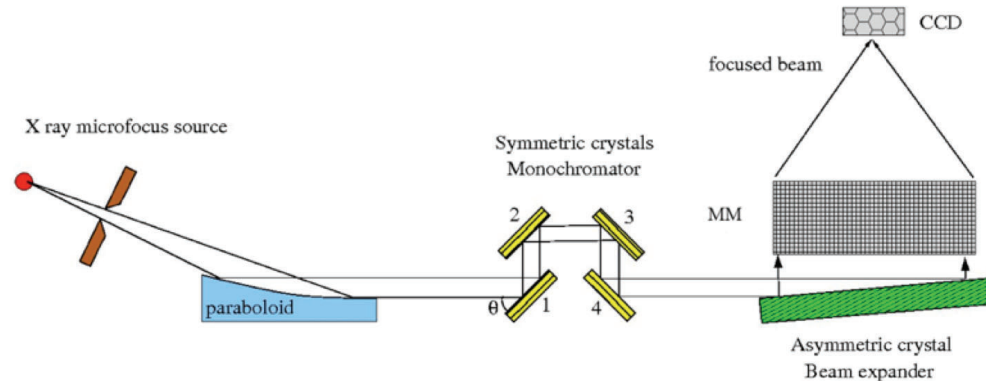

Figure 1: schematic of the existing beamline (4.51 keV) in the BEaTriX facility. The 1.49 keV beamline will have a separate short arm for beam collimation and expansion. The long arm for propagation to focus will be common to the two beamlines.

Each beamline in BEaTriX (the “short arm”) is based on a chain of optical components aimed at handling the X-ray flux generated by a microfocus X-ray source so as to make it broad and parallel.^{[12][13]} In the 4.51 keV beamline (Figure 1), the source has a titanium anode with a very small X-ray spot (35 μm FWHM) in the focus of a paraboloidal mirror, at a 4750 mm distance. The mirror has been polished and figured to 2 arcsec HEW^[14] to obtain a parallel, 6 cm high, but still narrow (~ 4 mm wide) beam. The polishing/figuring process was driven by accurate metrology^[15] and the expected PSF at 4.51 keV, including figure, roughness, and mid-frequencies, was analyzed using the 1D Fresnel diffraction methodology.^[16] The parallel X-ray beam at 4.51 keV is subsequently filtered by two Channel-Cut Crystals (CCCs) made of silicon cut parallel to the (220) planes, and finally expanded horizontally by means of another silicon crystal, asymmetrically cut with respect to the (220) planes.^[17] The asymmetry angle of 44.6 deg and the Bragg angle of 45.7 deg ensure that the beam is spread over the surface and deviated at a nearly-right angle, so that the final beam has approximately the same size of the crystal (17 cm × 6 cm).

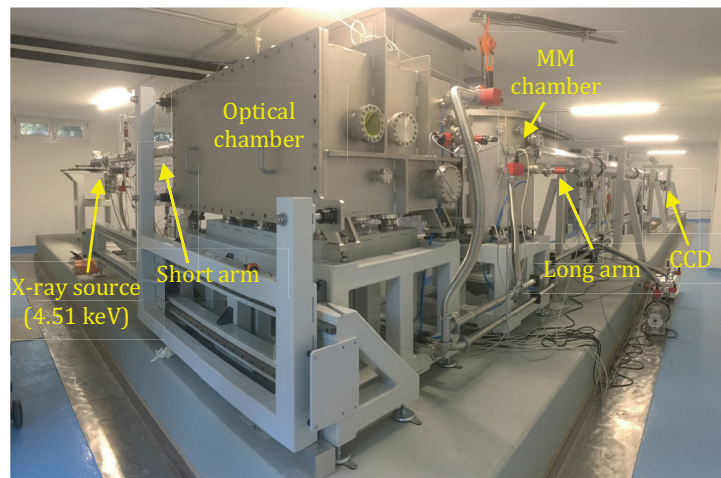

Figure 2: a picture of the BEaTriX facility, at INAF-Brera, Merate. To date, only the short arm for the 4.51 keV energy, visible on the left side of the picture, is operated. In the foreground, the squared optical chamber houses the optical elements that filter, collimate, and expand the beam to a 17 cm × 6 cm size. The cylindrical chamber at mid-right encloses the MM to be tested, whose focal spot is imaged at the end of the long arm (far right). All the components are under high vacuum (10⁻⁶ mbar).

Due to the dispersivity of asymmetric crystals, the incident beam has to be made highly monochromatic prior to expansion.^[18] This is possible owing to the sharply-peaked rocking curve in the two CCCs, that enables filtering a narrow band (90 meV HEW) within the Ti-K α 1 fluorescence line (~1 eV HEW). The monochromatization can be further improved (36 meV HEW), obviously at the expense of the flux, by rotating the 2nd CCC by 10 arcsec so as to detune the diffraction peaks and shrink their intersection.^[8]

Finally, all the system is enclosed in a vacuum tank (10⁻⁶ mbar) to enable the propagation of X-rays (Figure 2): the expanded beam illuminates the aperture of the SPO MM to be tested, placed on a hexapod for accurate alignment, then it propagates to the focal plane at a 12 m distance. The PSF can be measured directly on a CCD, placed at the end of the 12 m-long vacuum tube (the “long arm”).

While the first beamline at 4.51 keV is fully operational and behaving exactly as simulated, both in terms of flux and collimation,^[9] the construction of the second beamline of BEaTriX at 1.49 keV (the Al-K α 1 line) will start soon. This requires a second short arm with a dedicated source and optical components, which will be housed in the optical chamber, where appropriate room was left to this specific end. This paper reports the design of this new beamline of BEaTriX, with particular attention paid to the properties of the diffracting crystals. Finally, we show some performance simulations, aiming at the prediction of the achievable collimation and intensity of the 1.49 keV beam.

2. THE NEW BEAMLINE OF BEATRIX AT 1.49 KEV

The new beamline has a structure that resembles the existing one. The X-ray source will be from the same provider (*Incoatec GmbH*, Geesthacht, Germany), it will have the same X-ray spot size (35 μ m FWHM), the same hardware design; however, the titanium anode will be replaced with an aluminum one. Very likely, the source radiance will also be unchanged (10¹¹ ph/s/sterad). The paraboloidal mirror will have the same dimensions, aperture, and focal length. We are, in fact, already polishing the new mirror starting from another pre-ground paraboloid, made of fused quartz HOQ 310. The only difference will be in the coating, which is probably not required, because the material is already reflective at 1.49 keV.

The first relevant difference between the two beamlines is the beam expanding crystal, because silicon has a too small d-spacing to diffract X-rays at 1.49 keV: the choice crystal can be an organic one, with low absorption and larger d-spacing than silicon. We have selected and validated^[19] ADP (ammonium dihydrogen phosphate), an organic crystal manufactured in a size of 13 cm \times 7 cm by *Saint-Gobain* (Saint-Pierre-lès-Nemours, France) with the required asymmetry angle of the (101) planes, aiming at an expansion factor of 40 (Figure 3). This time, however, the beam is deviated by a 76.49 deg instead of a right angle, therefore it will be slightly narrower than the crystal width (12.6 cm). This different angle averts, on the other hand, mechanical conflicts between the two short arms, keeping the same beam exit direction for the two beamlines. In Figure 3, we show the crystal parameters of ADP (101), along with the asymmetry, the incidence, the reflection angles that will be used in the 1.49 keV beamline.

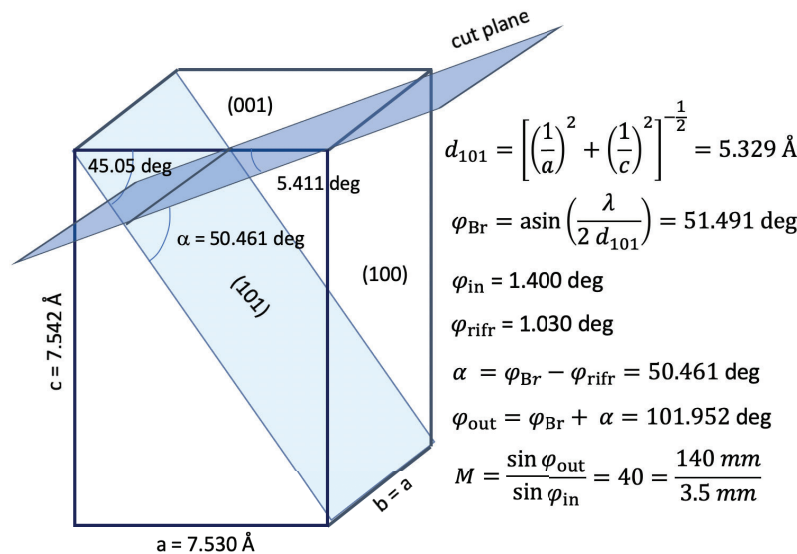

Figure 3: ADP has a tetragonal structure. Computation shows that, in order to form the correct asymmetry angle with the (101) planes, the incidence surface has to form an angle of 5.411 deg with the (001) planes. In this way, the expansion factor attains 40, a value sufficient to expand the beam width to 140 mm.

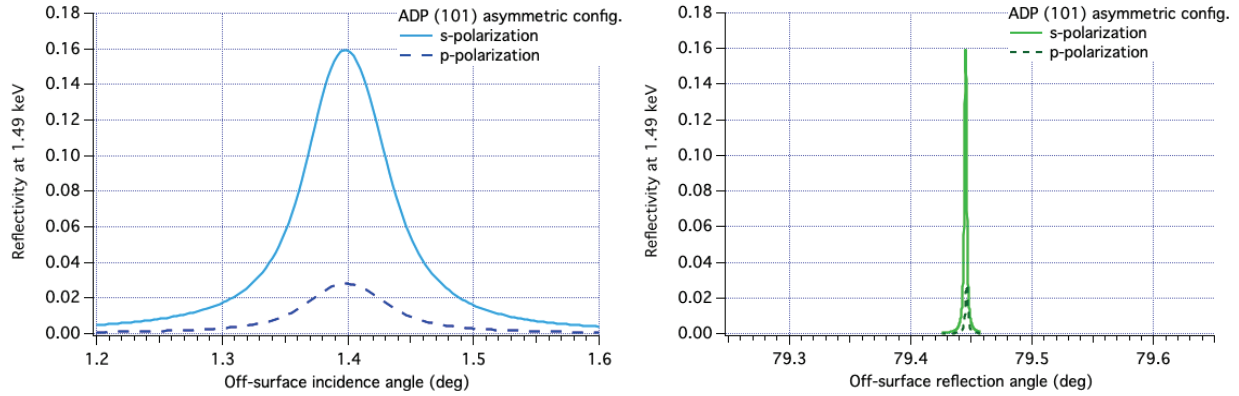

Figure 4: reflectivity curves of ADP (101) at 1.49 keV, asymmetrically-cut at 50.46 deg off-surface. Left: as a function of the incidence angle. Right: as a function of the reflection angle. The narrower angular distribution in the expanded beam is a noticeable feature of asymmetric crystals.

The reflectivity of the asymmetric crystal at 1.49 keV is shown in Figure 4, as a function of the incidence angle and of the reflection angle. We note the typical behavior of asymmetric crystals,^[20] i.e., the angular scale compression when the beam is expanded; however, unlike silicon, there is a small contribution from the p-polarization: therefore, the expanded beam *will not* be purely polarized in the vertical plane. The reflectivity of ADP (101) is significantly lower than Si (220).

3. THE QUEST FOR MONOCHROMATORS

Due to the dispersivity of the asymmetric ADP, tight monochromation is essential to ensure the collimation of the expanded beam. The bandpass must be much narrower than the natural width of the fluorescence line: in a previous paper,^[20] we have determined the required spectral purity of the beam, $\Delta\lambda$, in relation with the desired beam divergence $\Delta\varphi_{out}$ (assuming flawless mirror profile, and perfect alignment between the components). Replacing the parameters with those of ADP, we obtain the following result:

$$\Delta\varphi_{out} = \frac{\sin \alpha}{d_{101} \sin \varphi_{out}} \Delta\lambda \approx 160 \Delta E \frac{\text{arcsec}}{\text{eV}}$$

where φ_{out} is the exit angle and α is the asymmetry angle, both measured from the surface. From this formula we obtain that, aiming at a horizontal divergence of $\Delta\varphi_{out} \approx 1$ arcsec, the Al-K α 1 line should be filtered in a width $\Delta E \approx 6$ meV, six times narrower than needed for the 4.51 keV line. For achieving such tight spectral filtering, ADP (101) symmetric crystals are unsuitable, because their diffraction curve is too broad and it exhibits edges with marked tails; this would prevent us from de-tuning the crystals to sharpen the energy response.

Table 1: characteristic parameters of quartz (100) with asymmetric cut, which can be used as monochromators for the beamline at 1.49 keV. Two crystals are used in sequence, the first used as “expander” and the other as “compressor”. The second crystal has the incidence and the reflection switched.

Asymmetry angle	Bragg angle	Incidence angle (1 st crystal)	Reflection angle (1 st crystal)	s-pol. peak reflectivity	Refl. peak width FWHM	Expansion / compression factor
74 deg	78.566 deg	152.592 deg	4.513 deg	30%	44 arcsec	5.85
75 deg	78.565 deg	153.592 deg	3.393 deg	27%	40 arcsec	7.25
76 deg	78.564 deg	154.593 deg	2.520 deg	24%	36 arcsec	9.76
77 deg	78.563 deg	155.594 deg	1.521 deg	18%	29 arcsec	15.56

In principle, there are crystals with better properties at 1.49 keV, in symmetric configuration: for example, cesium chloride (110) has a peaked reflectivity curve reaching 98%, but large CsCl crystals are hard to find commercially. We have so opted for *asymmetric quartz* (100) that has a much narrower reflection curve, although at the expense of the peak reflectivity: moreover, large quartz crystals are commonly manufactured by several providers. The setup foresees a first crystal used as beam compressor (Figure 5, left), and a second one as expander (Figure 5, right). The first crystal has a very narrow rocking curve as a function of the incidence angle and energy, and this makes the crystal extremely selective in energy. The second crystal is anyway needed to restore the propagation direction of the beam parallel to the optical axis of the paraboloidal mirror, and to expand the horizontal size back to 3.5 mm before the incidence on the beam expander. In Table 1, we list some properties of quartz crystals with different asymmetry cut angles. Higher expansion/compression factors entail better monochromations, but at the cost of the reflectivity and of the final beam intensity.

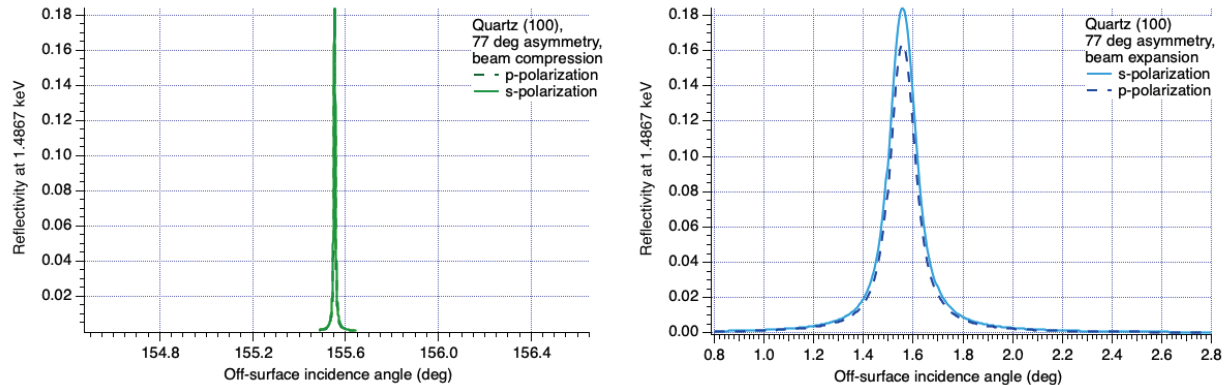

Figure 5: reflectivity curves of asymmetric quartz (100), as a function of the incidence angle, for the first crystal (compressor) and the second crystal (expander). The two plots have to be switched when seen as a function of the reflection angles.

4. FULL BEAMLINE SIMULATION

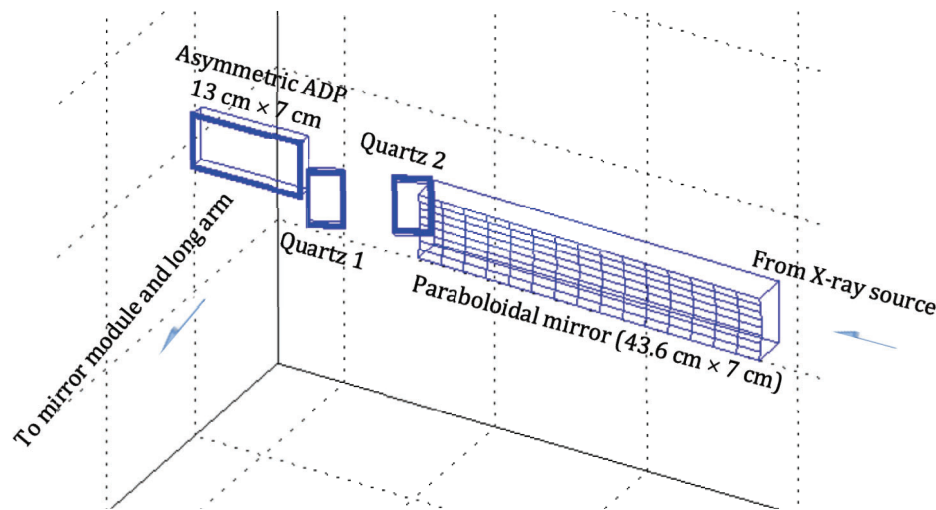

Figure 6: software model of the 1.49 keV beamline of BEaTriX. The main optical components are shown in 3D.

Just like we did for the 4.51 keV beamline,^[20] we have set up a full beamline simulation in an IDL code implementing the optical behavior of the optical components at their respective locations (Figure 6). This time, however, the asymmetric crystal response was adopted also for the monochromators. A ray-tracing example is shown in Figure 7, where the behavior of the asymmetric monochromators is highlighted, assuming the case with 77 deg asymmetry. The achievable *horizontal collimation* is, in the most favorable case, of approx. **3.3 arcsec HEW**, while the *vertical collimation* (**0.9 arcsec HEW**) is solely determined by the X-ray source size (Figure 8). Increasing the number of crystals would probably help to shrink the passing band further. Moreover, due to the lower reflectivity of

quartz with respect to silicon, the beam will be four times less intense than the 4.51 keV one (Figure 9). With just two crystals, we can expect a flux density of **2.5 ph/s/cm²** in the 77 deg asymmetry configuration (vs. *10 ph/s/cm² expected and measured at 4.51 keV*),^[9] which anyway remains perfectly suitable to sustain the 2 MM/day rate, as the integration time would pass from 30 min to 2 h. However, adding further monochromating stages would reduce the beam intensity to unacceptably low levels. Table 2 shows that the beam density can be increased by reducing the asymmetry angle, however degrading the horizontal collimation.

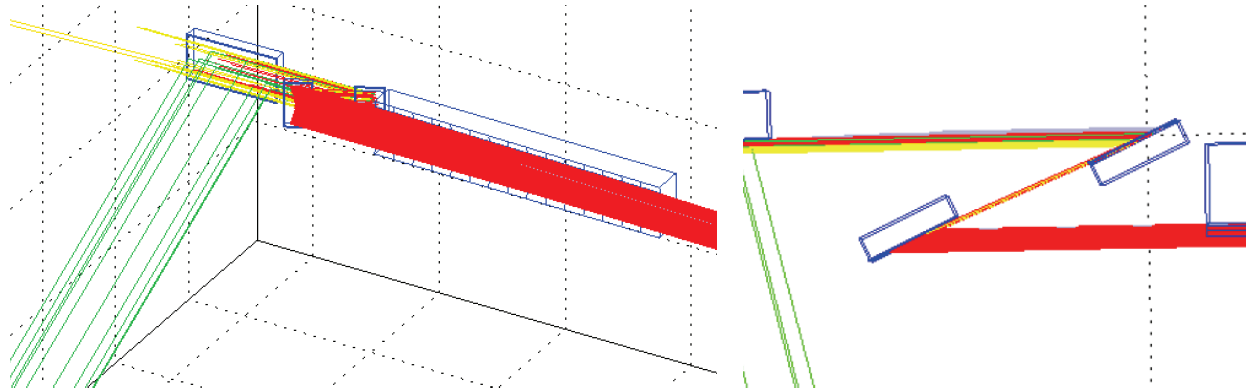

Figure 7: Left: ray tracing of the 1.49 keV beamline of BEaTriX. Red rays are absorbed, yellow rays have missed the incidence on the beam expander. Green rays are reflected by the asymmetric ADP crystal and illuminate the mirror module under test. Right: detail of the asymmetric monochromators.

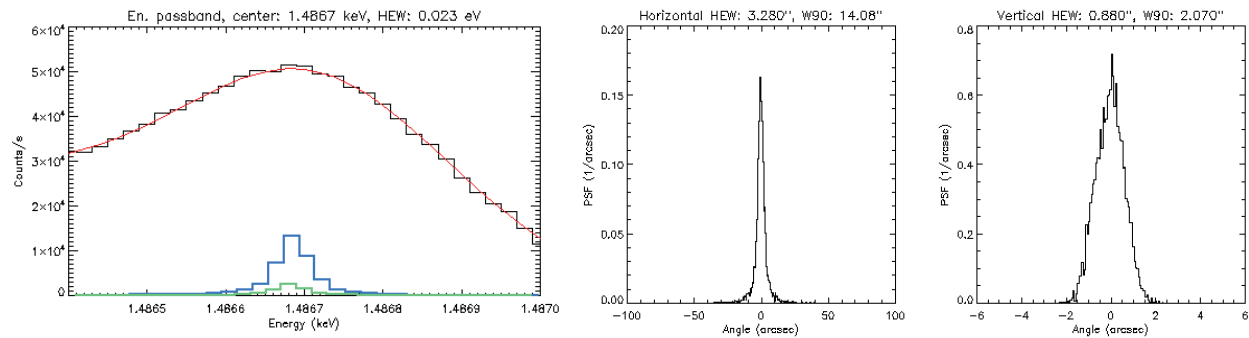

Figure 8: Left: the 23 meV energy band out of the asymmetric quartz monochromator, foreseen for the 1.49 keV beamline. The red line is the profile of the Al-K α line. The blue line is the filtered spectrum after the first diffraction (compression) and the green line the line after the second diffraction (expansion). Right: expected collimation of the expanded beam, in horizontal and vertical.

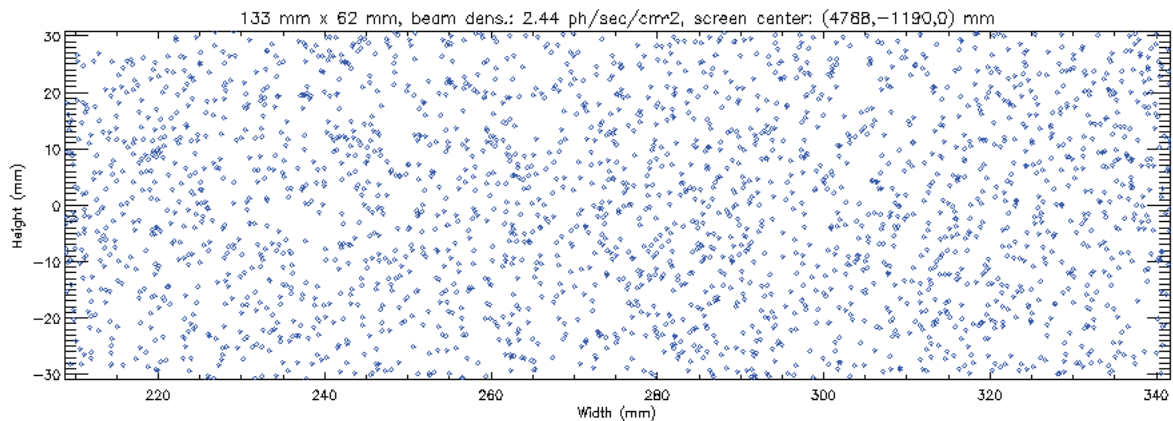

Figure 9: simulated expanded beam at the mirror module location, assuming a 10^{11} ph/s/sterad radiance of the microfocus source in the Al-K α doublet, showing the achievable beam size. In this simulation, we have assumed a 14 cm-wide ADP crystal: in reality, the beam will be 12.4 cm \times 6 cm because the crystal can be procured with a maximum width of 13 cm. For the simulation, 10^6 rays were traced. The collimating mirror is assumed as flawless.

Table 2: expected flux intensity, energy bandpass, divergence in horizontal and vertical direction for monochromating quartz crystal pairs, at 4 different asymmetry angles.

Asymmetry angle	Expanded flux intensity	Energy bandpass	Horizontal divergence	Vertical divergence
74 deg	8.60 ph/s/cm ²	33 meV	5.8 arcsec	0.9 arcsec
75 deg	6.67 ph/s/cm ²	30 meV	5.4 arcsec	0.9 arcsec
76 deg	4.50 ph/s/cm ²	26 meV	4.9 arcsec	0.9 arcsec
77 deg	2.44 ph/s/cm ²	23 meV	3.3 arcsec	0.9 arcsec

5. CONCLUSIONS

In this paper, we have shown a preliminary design of the forthcoming 1.49 keV beamline of the BEaTriX facility. A preliminary ray-tracing run showed that a 3 arcsec HEW collimation level can be reached adopting an asymmetric crystal in ADP as a beam expander and a couple of asymmetric quartz crystals instead of the symmetric CCCs in silicon being used in the 4.51 keV beamline. The price to pay is a lower intensity of the expanded beam, which will entail longer integration times needed for the full characterization of mirror modules (2 h instead of 30 min), which remains anyway fully compatible with the requirement of a 2 MM/day rate. Next activities to support the realization of the 1.49 beamline of BEaTriX will comprise:

- tolerance assessment for component alignments and mirror manufacturing errors;
- evaluation of an ellipsoidal concentrator between the source and the paraboloid, aiming at increasing the source radiance within the mirror aperture;
- assessment of performance and feasibility of alternative monochromators, such as CsCl (110), KAP (111), CsAP (111), in both symmetric or asymmetric configurations.

ACKNOWLEDGMENTS

The BEaTriX project is financed by ESA (contract #4000123152/18/NL/BW), AHEAD (grants #654215 and #871158), ASI (grant #2019-27-HH.0) and INAF funds.

REFERENCES

- [1]. Bavdaz, M., Wille, E., Ayre, M., Ferreira, I., Shortt, B., Fransen, S., Millinger, M., Collon, M., Vacanti, G., Barrière, N., Landgraf, B., et al., "ATHENA optics technology development," Proc. SPIE 12181, 121810T (2022)
- [2]. Collon M. J., Abalo, L., Babic, L., Barrière, N. M., Bayerie, A., Castiglione, L., Eenkhoorn, N., Girou, D., Günther, R., Hauser, E., et al., "The development of the mirror for the Athena X-ray mission," Proc. SPIE 12181, 121810U (2022)
- [3]. Valsecchi, G., Bianucci, G., Marioni, F., Vernani, D., Zocchi, F., Korhonen, T., Pasanen, M., Pareschi, G., Ferreira, F., Bavdaz, M., Wille, E., Doyle, D., "Facility for alignment, assembly, and integration of the SPO mirror modules onto the ATHENA telescope," Proc. SPIE 11822 (2021)
- [4]. Spiga, D., Pareschi, G., Pellicciari, C., et al., "Functional tests of modular elements of segmented optics for x-ray telescopes via an expanded beam facility," Proc. SPIE 8443, 84435F (2012)
- [5]. Spiga, D., Pellicciari, C., Bonnini, E., et al., "An expanded x-ray beam facility (BEaTriX) to test the modular elements of the ATHENA optics," Proc. SPIE 9144, 91445I (2014)
- [6]. Pellicciari, C., Spiga, D., Bonnini, E., et al., "BEaTriX, expanded soft x-ray beam facility for test of focusing optics: an update," Proc. SPIE 9603, 96031P (2015)
- [7]. Spiga, D., Pellicciari, C., Salmaso, B., et al. "Design and advancement status of the Beam Expander Testing X-ray facility (BEaTriX)," Proc. SPIE 9963, 996304 (2016)

- [8]. Salmaso, B., Spiga, D., Basso, S., Ghigo, M., Giro, E., Pareschi, G., Tagliaferri, G., Vecchi, G., et al., "Progress in the realization of the beam expander testing x-ray facility (BEaTriX) for testing ATHENA's SPO modules," Proc. SPIE 10699, 1069931 (2018)
- [9]. Basso, S., Salmaso, B., Spiga, D., Ghigo, M., Vecchi, G., Sironi, G., Cotroneo, V., Conconi, P., Redaelli, E., Bianco, A., Pareschi, G., Tagliaferri, G., Sisana, D., Pellicciari, C., Fiorini, M., Incorvaia, S., Uslenghi, M., Paoletti, L., Ferrari, C., Lolli, R., Zappettini, A., Sanchez del Rio, M., Parodi, G., Burwitz, V., Rukdee, S., Hartner, G., Müller, T., Schmidt, T., Langmeier, A., Della Monica Ferreira, D., Massahi, S., Gellert, N. C., Christensen, F., Bavdaz, M., Ferreira, I., Collon, M., Vacanti, G., Barrière, N. M., "First light of BEaTriX, the new testing facility for the modular X-ray optics of the ATHENA mission," A&A 664, A173 (2022)
- [10]. Bradshaw, M., Burwitz, V., Hartner, G., Langmeier, A., Vacanti, G., et al., "Testing ATHENA optics: a new measurement standard at the PANTER x-ray test facility," Proc. of SPIE 11852, 1185223 (2021)
- [11]. Krumrey, M., Muller, P., Cibik, L., Collon, M., Barrière, N., Vacanti, G., Bavdaz, M., Wille, E., "New X-ray parallel beam facility XPBF 2.0 for the characterization of the silicon pore optics," Proc. SPIE 9905, 99055N (2016)
- [12]. Salmaso, B., Spiga, D., Basso, S., Ghigo, M., Giro, E., Pareschi, G., Tagliaferri, G., Vecchi, et al., "BEaTriX (Beam Expander Testing X-ray facility) for testing ATHENA's SPO modules: advancement status," Proc. SPIE 11180, 1118026 (2019)
- [13]. Salmaso, B., Basso, S., Ghigo, M., Spiga, D., Vecchi, G., Sironi, G., Cotroneo, V., Conconi, P., Redaelli, E., Bianco, A., Pareschi, G., Tagliaferri, G., Sisana, D., et al., "X-ray tests of the ATHENA mirror modules in BEaTriX: from design to reality," Proc. SPIE 12181, 121810W (2022)
- [14]. Vecchi, G., Cotroneo, V., Ghigo, M., Basso, S., Salmaso, B., Sironi, G., Spiga, D., Conconi, P., Pareschi, G., Tagliaferri, G., Burwitz, V., Hartner, G., Müller, T., Rukdee, S., Schmidt, T., Christensen, F., Della Monica Ferreira, D., Gellert, N., Massahi, S., Bavdaz, M., Ferreira, I., "Manufacturing and testing of the X-ray collimating mirror for the BEaTriX facility," Proc. SPIE 11822, 118220N (2021)
- [15]. Sironi, G., Citterio, O., Pareschi, G., Negri, B., Ritucci, A., Subranni, R., Orlandi, A., Borghi, G., Stroebel, M., Arnold, J., Widemann, R., et al., "MPR: innovative 3D free-form optics profilometer," Proc. SPIE 8147, 814718 (2011)
- [16]. Raimondi, L., Spiga, D., "Mirrors for X-ray telescopes: Fresnel diffraction-based computation of point spread functions from metrology," A&A 573, A22 (2015)
- [17]. Christensen, F., Hornstrup, A., Frederiksen, P., et al., "Expanded beam x-ray optics calibration facility at the Daresbury Synchrotron," Proc. SPIE 2011, 540 (1994)
- [18]. Sanchez del Rio, M., Cerrina, F., "Asymmetrically cut crystals for synchrotron radiation monochromators," Review of Scientific Instruments 63, 936 (1992)
- [19]. Ferrari, C., Beretta, S., Salmaso, B., Pareschi, G., Tagliaferri, G., et al., "Characterization of ADP crystals for soft x-ray optics of the Beam Expander Testing X-ray facility (BEaTriX)," Journal of Applied Crystallography 52, 599-604 (2019)
- [20]. Spiga, D., Salmaso, B., Bavdaz, M., Pellicciari, C., Basso, S., Burwitz, V., Ferreira, I., Ghigo, M., Giro, E., Pareschi, G., Sanchez del Rio, M., Tagliaferri, G., Vecchi, G., Wille, E., "Optical simulations for the laboratory-based, expanded and collimated X-ray beam facility BEaTriX," Proc. SPIE 11110, 111100E (2019)