

Light Work at Chiang Mai University, Thailand.

Wongtawatnugool C., Ngamjarrojana A., and Lacharojana S.
Laser and Applied Optics Laboratory, Physics Department, Faculty of Science,
Chiang Mai University, Chiang Mai 50200, Thailand

ABSTRACT

The teaching and learning optics in Thailand is some how rather slowly developed. This is could possibly due to its importance, as seen by the educators and scientists in Thailand, was not so pronounced in the past. This made Thai scientists and researchers in many other disciplines lag of basic optics knowledge to getting involve with today advanced optics and photonics technologies. The need for high precision and high speed of the measurement and control in today experiment urges them to get involve in optics and photonics techniques more than ever before. At Chiang Mai university we offer 4-credit course: Optics and Spectroscopy. It covers a conventional optics course detail as referred in most conventional optics text books. Advanced optics course is also offered at higher level. The development of research activities utilizing optics and photonics techniques has been very slow due to the higher cost for most of the equipment involved. Very often that we have to assemble our own designed microcomputer-based equipment. The multi-scaler and a computer to serve as a photon correlator in dynamic light scattering (DLS) system to study correlation length in a liquid mixture at its critical point is one of the examples. The Ph.D. projects work in our section involve medical laser and electro-optics properties of a liquid mixture are some examples of our interest.

Keywords: Photon Correlator, DLS, Medical Laser

1. INTRODUCTION

It was some time ago that optics in many countries was treated as a dead-end subject, this was also true for Thailand. The curriculum in most universities in Thailand included only one course of fundamental optics as basic requirement for basic science knowledge. At Chiang Mai university, we have extended optics knowledge of physics major students further by adding a compulsory 4-credit course in optics and spectroscopy. It was around 1976 when we started to offer an Advanced Optics course as for the preparation of the students who might be interested in using an optical technique for their senior projects. The course was aimed for students' optics knowledge background as well as a preliminary study of the small-scaled project of our interest. The Advanced Optics course is a 3-credit course includes 30 hours of lecture plus total of 45 hours laboratory work of which mini-project is included. It was also in 1976, when our department started to offer the projects for students leading to master degree in physics utilizing light scattering and photon correlation technique and being extended further to the Ph.D. degree level in 1995. Research activity involving the use of a sophisticated optical system and newly developed photonics technique was hardly reached in Thailand due to the high cost of the parts and systems involved. In order to standardize our measurements, the fabrication of optical system, and also the electronic modules involved has been slowly developed since 1976. This includes all others facilities needed in certain experiments. With the collaboration with some universities and willingness to help of people involved, we have succeeded in assembling ourselves parts and equipment such as light detection module, temperature control unit, 1.4-ton vibration-free optical tables, FFT-spectrometer system, photon correlator. These mentioned home-made devices enable us to perform better experiments while the computer interfacing on to the system make life easier after the automation is introduced into the experiments. Some in details of the developed systems as well as example experiments shall be illustrated as to follow.

2. METHODOLOGY

2.1 Vibration-free optical table

In many scientific experiments, especially in physical science, the experimental setup must be totally isolated from external environments. A vibration caused by the external forces that can reach an experimental system could affect

most of serious experiments. The vibration cannot only cause the physical instability of an experimental setup but also introduce an unwanted energy to the sample under investigations. The vibrations in a building could come from many sources such as swaying of a tall building due to the wind which could introduce the vibration of the frequency around 0.1 to 5 Hz. while machinery vibration or people footsteps in the building or any near by traffic create the vibrations of frequency around 10 to 100 Hz. These vibrational waves travel through the building constructions to any parts of the building.

In our laboratory we constructed the optical tables off a 1'x4'x8' solid concrete slab of the weight about 1.4 tons calculated from the density of the materials used. Four inflated car rubber-tubes were used as the vibration isolators sandwiched between the concrete slab and the wooden-bed. Two 4"x4"x4' Newport sealed hole steel core breadboards on top of the concrete slab were used as the working area for their high quality flatness and for the ease of a optical system assembling. These optical table systems performance were tested utilizing the 1570C Seismograph from Bison Co-operation for amplitude of vibration measurements. The experiment was carried out to find the optimum conditions, numbers and position of the rubber-tubes, for the best performance of the system.

2.2 FFT-spectrometer

Most spectrometers utilizing a linear array detector would normally be assembled in the fashion of a Fourier transform spectrometer (FTS) arrangement and the amplitude spatial-distributions of the interferograms of the two-beam interference are recorded [1-3]. An appropriate fast Fourier transform (FFT) computation is used to transform those recorded spatial amplitude-distribution into the corresponding power spectrum. A FTS uses no dispersive devices; therefore it's spectral resolution depends mainly on the geometry of the array detector and the optical setup of the system. The constructed FTS in our laboratory; a TC103 2048-pixel CCD light detecting array cooperated with the PC401 CCD evaluation kit circuit board from Texas Instruments were used originally as a spatial light-intensity distribution detection system. The control circuit board provided a triggered pulse train of the frequency about 200 kHz to trigger the electronic circuit to generate an analog signal from an accumulated charges of each pixel in the light detection process. The wave-train for each set of 2048-channel signal outputs were repeatedly appeared at the output of the evaluation circuit board.

In order to capture the output wave train, the output signal was connected to the IQ300 HiTech data acquisition system. One off 8 input channels of the IQ300 provides 16-bit analog to digital conversion (ADC) with 32K data points on-board memory at the maximum sampling rate of 500 kHz. The synchronization between the IQ300 and the CCD evaluation circuit board was made by supplying the triggered signal from the evaluation circuit board to the IQ300 external trigger input. A 386-based microcomputer was used as a controller and for the data acquisition in the experiments using an IEEE488 interface card. The computer software subroutines were written in power Basic language, machine language, and turbo Pascal language. The machine language was used whenever higher speed operations were needed while turbo Pascal gave more friendly control to the IQ300 on data transfer process depended largely on the nature of the hardware used in the system. However, all operations of the controls and data-acquisition routines were integrated into one startup program which had a selectable menu for all operations just for the simplicity in doing the experiments. The accumulated spatial distribution intensity of the detected signals then go through the FFT subroutine for the power spectrum of the in coming light. The system set-up is illustrated in Fig. 1.

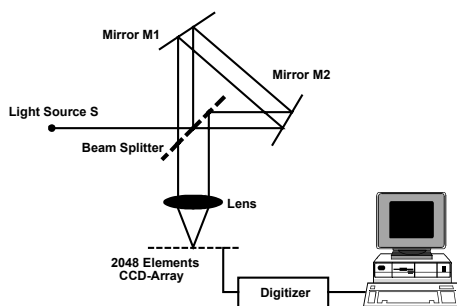

Fig.1 Schematic diagram of a triangle common-path FTS.

2.3 Critical opalescence in a liquid mixture: Dynamic light scattering

The light scattering experiment and photon correlation technique is our main technique involved in our research work. One system of interest is a phase-separation phenomena of a liquid mixture, and the mixture of Methanol and Cyclohexane is one of the examples. When a liquid mixture at certain conditions where a well-mixed liquid mixture starts to separate into two phases; the scattered light that caused by local statistical fluctuation of the refractive index in thermodynamic equilibrium give three contributions to the scattered laser light [4]. The unshifted frequency, Rayleigh line, results from entropy fluctuations while the two frequency shifted Brillouin lines caused by pressure fluctuations of the liquid sample. The central, unshifted, peak can be analyzed for the thermal diffusivity D of a liquid while the mutual diffusion coefficient D_{12} must be also included to account for the case of a liquid mixture [5]. The light scattering experiment measurement has been utilized to study the statistical fluctuations and thermal diffusivity at the vicinity of the phase separation temperature of various liquid mixture compositions. It was observed at the different highs around the interface where the number density of each constituents should not be the same as approaching the liquid-liquid phase separation temperature. The scattered intensities and the thermal diffusion constants D of the samples of different compositions at various temperatures can be studied. The phase-separation temperature as defined by the temperature at which the sample gave maximum scattered intensity are found to be slightly different from the temperatures at minimum diffusion constants D . This phenomena was found to be true for all samples. The characteristic lengths as defined by Stokes-Einstein relation, $D = kT / 6\pi\eta L$, could be also studied off the same set of data.

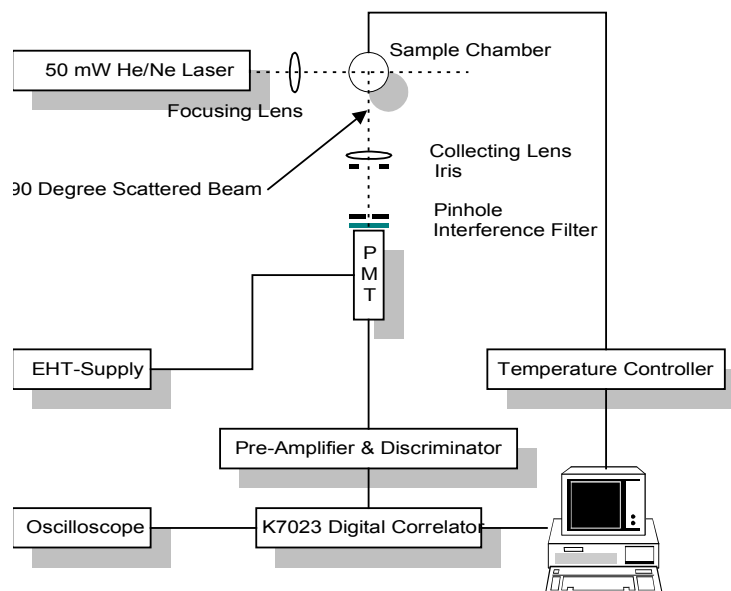

Fig.2 Light scattering set-up

Fig.2 shows the system arrangement of the light scattering set-up that used in our laboratory. The 50 mW He/Ne laser beam of wavelength 632.8 nanometre was focused to irradiate the scattering volume of interest. The irradiated scattering volume is defined by the geometry of the optical arrangement of the laser system output while the scattered beam collecting optic defines an observed volume. The scattered beam was collected at 90 degree scattering angle to avoid it's back reflection components from the cell's walls. A laser-wavelength interference filter was used to prevent stray light to get into the photomultiplier tube (PMT) that used as a light detector device. In forming a time correlation function; the Malvern K7023 digital correlator was used with 72 delayed channels and the shortest sample time setting is 50 nanoseconds. A microcomputer PC was interfaced with the correlator in this experiment for data transfer and to automate the experiments utilizing compiled basic software. The K7023 correlator later on has been replaced by the SR430 multi-channel scaler. With the help of computer programming the time correlation of the incoming signal,

$\langle n(t)n(t+\tau) \rangle$, can be calculated. The new arrangement of our photon corrector proved to work perfectly well. Typical time correlation function as shown in Fig.3.

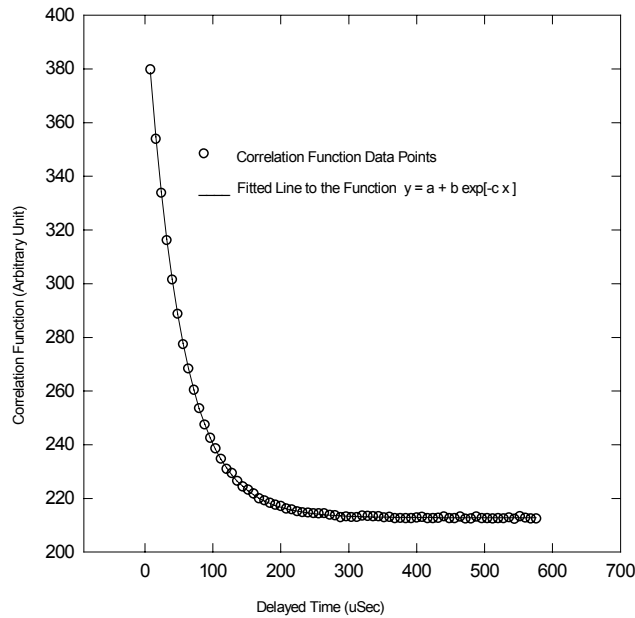

Fig.3 Typical time correlation function of light scattering off a liquid mixture.

2.4 Birefringence property of a liquid mixture as approaching the phase separation temperatures

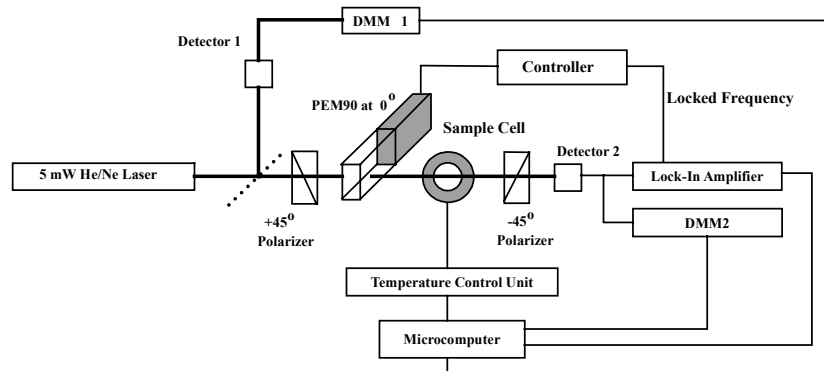

Fig.4 Birefringence measurement experimental set-up

As a liquid mixture approaches its liquid/liquid phase separation temperature from single phase mixture, light scattering intensity off a liquid mixture remarkably increased due to its high fluctuation of number density within the liquid mixture. As for the facts for the critical opalescence that, three major physics phenomena changed namely; the scattering intensity becomes very intense and the sample becomes opaque, the compressibility goes infinite, and the correlation length becomes much larger. It's interesting to see if the electronic configuration of the correlated submacro-

structure is symmetry. It's not too difficult to imagine that the orientation of the constituents of the mixture should become some how differ from random orientation as it was at higher temperature or as it is as for a pure liquid. This experiment was performed to study the birefringence property of a methanol/cyclohexane liquid mixture as approaching its phase separation point utilizing the modulated polarized light laser beam entering the samples. The ratio of ac-to-dc signal of the transmitted laser beam intensities gives the birefringence of the sample of interest. The results found from these experiments indicated that the birefringence clearly increased toward the maximum value and then gradually dropped to minimum value after passing through the phase separation temperature, as defined by light scattering measurement. The experimental set-up to study the optical property of the liquid mixture is as shown in Fig.4 The polarized light of the 5 mW He/Ne laser was sent through the photoelastic modulator (PEM) at the angle of 45° to the modulation direction of the PEM such that the delayed and undelayed components of the laser beam could be independently treated as the beam was allowed to go through the sample of interest. The photo diode light detector fed the output signal to a lock-in amplifier locked onto the modulation frequency of PEM for ac-signal detection while a conventional 6-digit digital multimeter was used to detect the dc-signal. The ratio of ac-to-dc signal leads to the birefringence of the sample. The experiments was conducted automatically by the software written in Basic designed for system control and data acquisition through the IEEE-488 interface system

3. RESULTS

3.1 Vibration-free optical table

Physics of a traveling wave from the floor to the table-top could be analyzed in details similar to physics of vibration of a mass-spring system. As a vibration travels from the floor through inflated rubber-tube vibration isolator where air pressure affects the transmissibility of a vibration through the compliance C of the compressed air, and the elasticity of the rubber acts mainly on the damping coefficient of the vibration isolator system. The amplitude of a vibration measured at the table top for each point was compared with respect to the amplitude of vibration on the floor measured simultaneously. The study of contour and amplitude graphs of the vibration amplitude for each conditions gave the condition for optimum performance as for the case used 4 inner-tubes. The example of contour and vibration amplitude graphs are shown in Fig.5. From these measurements it was found that the overall performance of

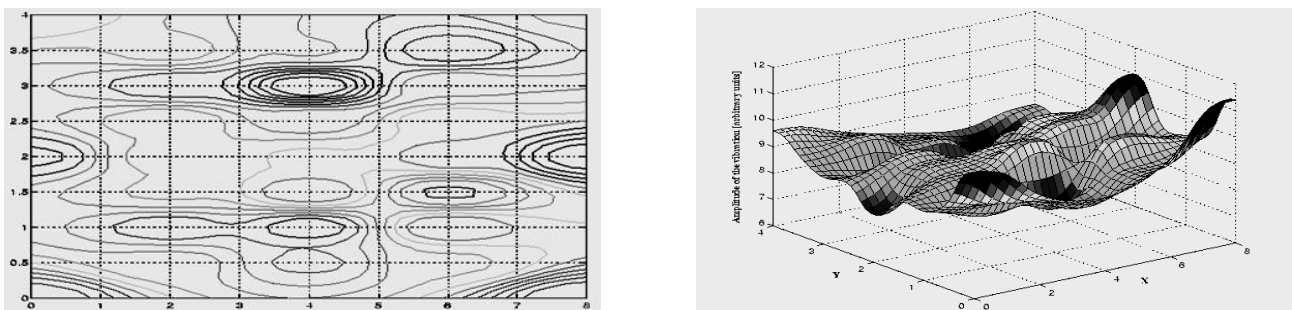

Fig.5 Contour map and surface map of amplitude of vibration measured on the table top.

our optical table system should have the maximum transmissivity T about 0.05 which is good enough for most optics experiments, while some very good commercial systems has the T values around 0.01-0.06 at 10 Hz.

3.2 FFT-spectrometer

The CCD-array detector and it's evaluation kit circuit board were used at room temperature without any sophisticated arrangements for noise reduction purposes as involved in most laboratories. However all those noise parameters as described in details, for instance by Talmi and Simpson [6], were taken for granted that they could be neglected for a relative measurement of the spectra of interest. The detected interferograms using the constructed FTS and their Fourier transforms for standard Hg/Zn/Cd lamps are displayed in Fig. 6.

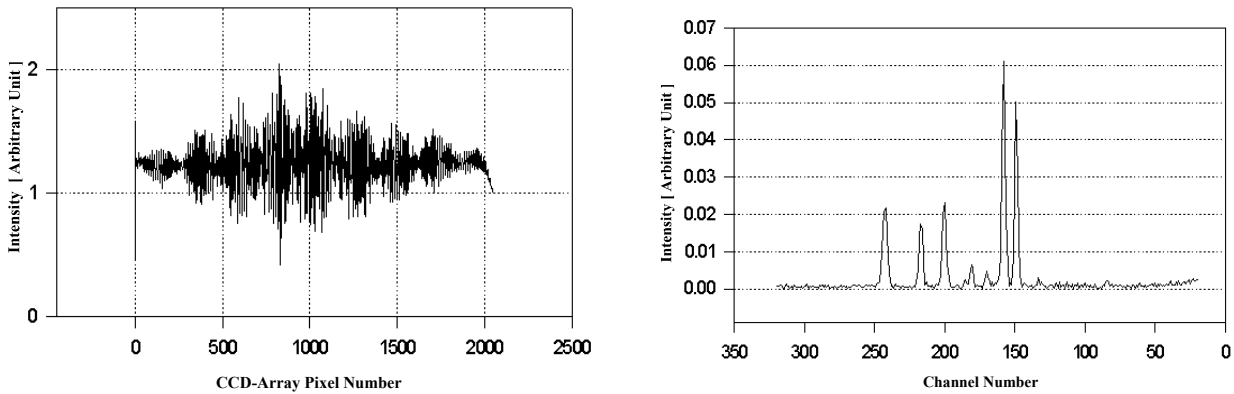

Fig.6 Interferogram and it's Fourier transform of the signal from Hg/Zn/Cd spectrum lamp.

3.3 Critical opalescence in a liquid mixture: Dynamic light scattering

The use of dynamic light scattering to study dynamic properties of the methanol/cyclohexane liquid mixture were conducted at three points within the sample around the interface region at one millimeter different in highs. for both scattered intensity measurement and correlation function of the scattered laser beam. The time correlation function obtained from both K7023 digital correlator and the SR430-correlator are scientifically identical and a typical time correlation function is shown in Fig.3 The light scattering measurements were performed on seven liquid mixtures at various compositions of methanol/cyclohexane starting from 25.9% to 31.2% of methanol by volume at the temperatures ranged from 47.5° C to 45.7° C in the steps of approximately 0.06° C and the results could be concluded as follows.

3.3.1 For all samples; the intensities were erratically scattered from all three scattering regions of interest at the temperatures lower than liquid-liquid phase-separating temperature where the samples started to separate into two phases especially for the light scattered from the upper region where the mixture was slowly turned to be cyclohexane-riched mixture compared to the lower region where the mixture became methanol-riched mixture. The described phenomena reflects the behavior of the density fluctuations in those three regions.

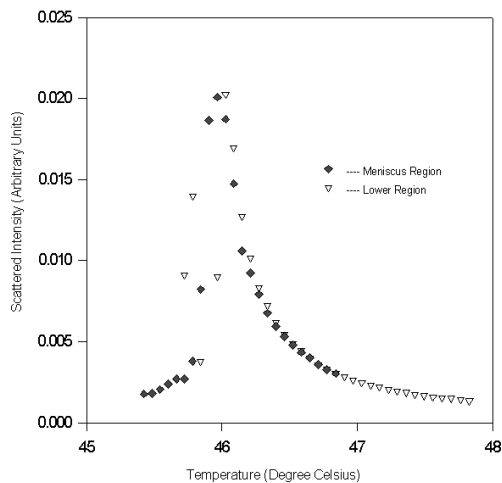

Fig.7 Scattered intensity from meniscus region and lower region off 31.2%-methanol sample.

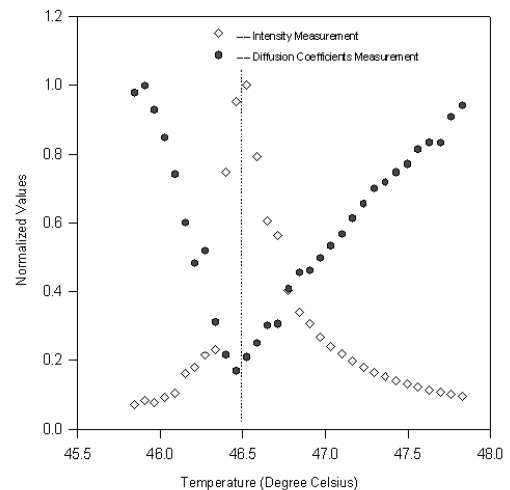

Fig.8 Scattered intensity and the diffusion-coefficient measurements from lower region off 29.0%-methanol sample.

It was also found that the scattered intensities from the meniscus region and the lower region followed a similar trend with different characteristic when a sample approached phase-separating temperature from higher temperature side as shown in Fig.7 for the 31.2%-methanol sample.

3.3.2 In general cases, the intensity of the scattered light should become very large at phase-separating temperature similar to the critical opalescence phenomena in a vapour-liquid phase separation in a liquid. The diffusivity should approach the minimum value while the correlation length increases rapidly. From these facts the phase-separating temperatures as defined by light scattering intensity maximum and that defined by diffusion coefficient, thermal diffusivity, minimum should occur at the same temperature. From all samples in this experiment the results suggested that the two temperatures are slightly different as shown in Fig.8 for the sample of 29.0% methanol where both diffusion constants and the scattered intensities at various temperatures are plotted. This evidence suggests that when a liquid mixture undergoes phase separation, the difference in volume fractions of the constituents at different regions affects the local density fluctuations differently but not the same effect can be seen in the thermal diffusivity measurements. In Fig.9 the diffusion constants measured from the sample of 29.0% methanol are plotted for all three regions. It could be seen from those data points that there is very little trend to indicate any different characteristics in nature at higher temperature. At the temperatures lower than liquid-liquid phase-separating temperature the scattered intensity fell off very rapidly, as may be seen from Fig.7, therefore the signal to noise ratio in forming a time correlation function is much less compared to those for higher temperature side, this results in the more scattered of the D values at the lower temperature region.

3.3.3 The characteristic lengths for each sample were calculated by applying Stokes-Einstein relation and the results are displayed in Fig.9. It may be useful to notice that the Stokes-Einstein relation does take into account of the hard sphere, Stoke's law, model for the scattering volume in place of the fluctuations in the liquid. However, these results are comparatively presented for the phenomena in the liquid mixtures as if they were the solid scatterers in a solution while Fig.8 presents the corresponding diffusion constants for the 29.0% methanol mixture. In these calculations the value of liquid viscosity at different temperatures was left as a systematic constant for the reason that the sample-temperature range was only about 2 degrees Celsius in these measurements.

The light scattering and the PCS techniques can be used to study hydrodynamics properties of a liquid mixture at the liquid-liquid phase-separating temperature where the scattered laser beam is more intense compared to those scattered from a pure liquid. It is clear from those results that the thermal diffusivities, $D = \lambda / C_p$, in three regions behaved in the same manners for all samples and the D values diverge when approaching phase-separating temperature. It can be

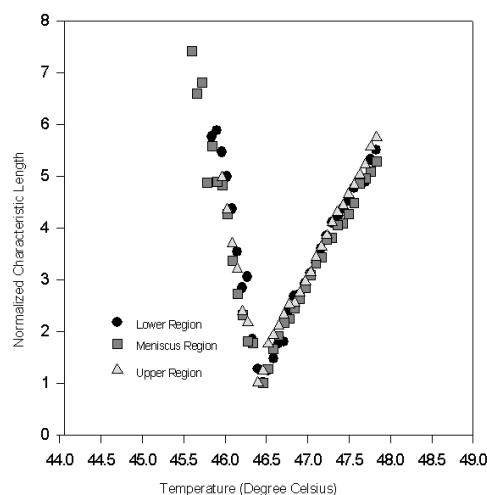

Fig.9 The characteristic lengths in the liquid mixture at three regions of interest off 29.0%-methanol sample.

concluded from this experiment that A diverges less strongly than the specific heat at constant pressure causes the diffusion constant D approaches minimum value at a phase separation point. This assumption works for all three regions within the liquid mixtures and the difference in volume fractions of the constituents seems to have no effect on this ratio. On the other hand; it would be much simpler, as one would expect, to discuss on different nature of the scattered intensity from those three regions under the assumption of differences in statistical fluctuations in refractive indices in each region. However, the central peak intensity can be related to the specific heats of the samples through equation $I_R = I - C_V / C_P$. When a sample temperature approaches a liquid-liquid phase-separating temperature C_P increases faster than C_V and at phase-separating temperature $C_P \gg C_V$ in all three regions of interest as shown in the intensity graph of Fig.7.

3.4 Birefringence property of a liquid mixture as approaching the phase separation temperatures

The change of the birefringence property of the methanol/cyclohexane liquid mixture was clearly observed in a liquid mixture as it came closer to the liquid/liquid phase separation temperature. The ac-signal was gradually increased as approaching the phase separation temperature to the maximum value and then gradually decreased to the minimum value at the phase separation temperature, while the dc-signal remain constant through out the experiment and drop very rapidly to minimum at the phase separation temperature due to the very strong scattering off the sample at this point. This in turn gives the birefringence of the sample become very high. The precision in the measurement of every point of 160 consecutive measurements is very high; the error bars are far too small to be shown here. For the points close to the phase separation temperature give increasingly larger error bars for the delayed measurements of the birefringences at the same conditions as shown in Fig 10, while this phenomena does not appear out-side the critical region. The result of this experiment indicates the development of the crystal-like structure within the liquid mixture as approaching the liquid/liquid phase separation temperature.

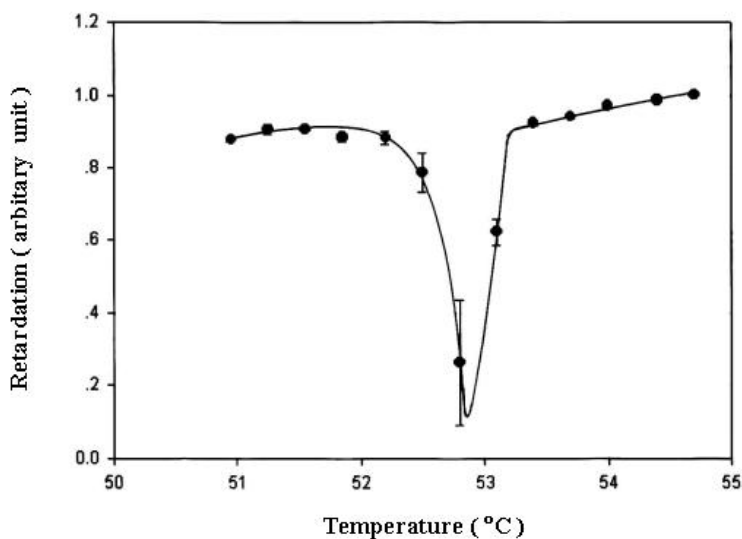

Fig.10 Birefringence measured of a liquid mixture at different temperatures.

4. CONCLUSIONS

As for the conclusions; we at the physics department Chiang Mai university might not have a chance to do much in the field of very advanced optics and photonics research and developments. We could be only the ones who fond in love with optics and photonics technology, and very keen to develop our tools for studying physics utilizing laser, computer, and electronics. For those students who might become interested in getting involve with the optical techniques, they might find great difficulty if their optics knowledge is insufficient. However, we have found also that it is not too difficult to try. The work on the birefringence properties of liquid mixture shall be conducted further in the near future.

The electro-magnetic field is planned to introduce into the system to force the crystal-like structure of the mixture to take only certain orientation within the liquid.

REFERENCES

1. Okamoto, T., Kawata, S. and Minami, S., *Appl. Opt.* 24, p4221 (1985).
2. Ebizuka, N., Wakaki, M., Kobayashi, Y. and Sato, S., *Appl. Opt.* 34, p7899(1995).
3. Dierking, M.P. and Karim, M.A., *Appl. Opt.* 35, p85(1996).
4. Berne, B and Pecora, R, *Dynamic Light Scattering*. Wiley, New York (1976).
5. Wu, G., Fiebig, M. and Leipertz, A., *Int. Journal of Heat and Mass Transfer*, 31, pp2555-2558 (1988).
6. Talmi, Y. and Simpson, W., *Appl. Opt.* 19, p1401(1980).